

ECOCRIB 2 CRIB CONFIGURATION

BLOCK DIMENSIONS: 600x150x150mm
TOP SEALER PAD: 600x600x40-60mm

The ECOCRIB cribbing block system is designed to support and stabilise heavy equipment during a lifting/lowering operation. It's compact size means you can quickly and safely build a temporary crib to the desired height, with the flexibility of two configuration options depending on the required load capacities.

2-CRIB KIT 6

IP-72099

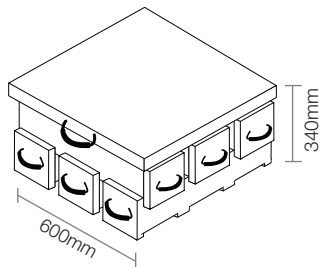

- 2 x 2 Crib Set-Up
- Weight 91.50kgs
- Load Capacity 30.00t
- 6 Cribbing Blocks
- 1 Top Pad (600x600x40mm)

2-CRIB KIT 8

IP-72100

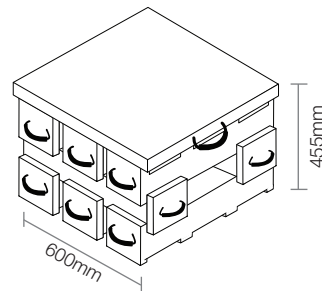

- 3 x 2 Crib Set-Up
- Weight 117.50kgs
- Load Capacity 34.00t
- 8 Cribbing Blocks
- 1 Top Pad (600x600x40mm)

2-CRIB KIT 10

IP-72101

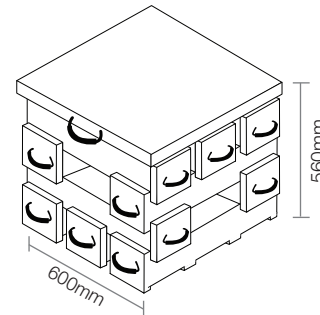

- 4 x 2 Crib Set-Up
- Weight 143.50kgs
- Load Capacity 38.00t
- 10 Cribbing Blocks
- 1 Top Pad (600x600x40mm)

2-CRIB KIT 12

IP-72102

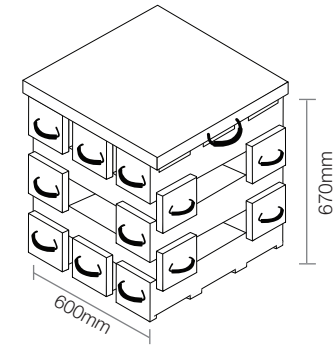

- 5 x 2 Crib Set-Up
- Weight 169.50kgs
- Load Capacity 42.00t
- 12 Cribbing Blocks
- 1 Top Pad (600x600x40mm)

2-CRIB KIT 14

IP-72103

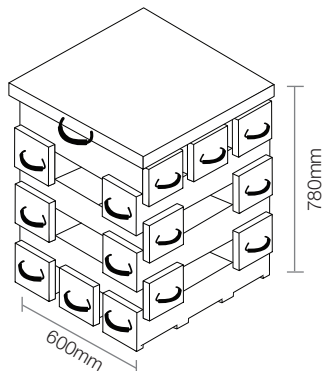

- 6 x 2 Crib Set-Up
- Weight 195.50kgs
- Load Capacity 46.00t
- 14 Cribbing Blocks
- 1 Top Pad (600x600x40mm)

2-CRIB KIT 16

IP-72104

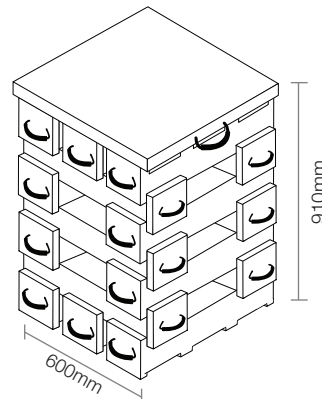

- 7 x 2 Crib Set-Up
- Weight 221.50kgs
- Load Capacity 50.00t
- 16 Cribbing Blocks
- 1 Top Pad (600x600x50mm)

2-CRIB KIT 18

IP-72105

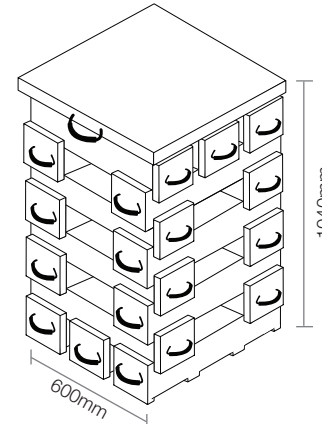

- 8 x 2 Crib Set-Up
- Weight 247.50kgs
- Load Capacity 54.00t
- 18 Cribbing Blocks
- 1 Top Pad (600x600x60mm)

2-CRIB KIT 20

IP-72106

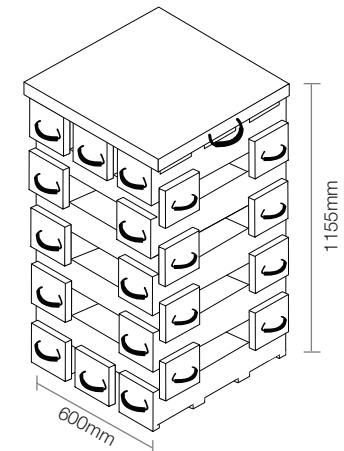

- 9 x 2 Crib Set-Up
- Weight 273.50kgs
- Load Capacity 58.00t
- 20 Cribbing Blocks
- 1 Top Pad (600x600x60mm)

ECOCRIB 3 CRIB CONFIGURATION

BLOCK DIMENSIONS: **600x150x150mm**
TOP SEALER PAD: **600x600x40-60mm**

The ECOCRIB cribbing block system is designed to support and stabilise heavy equipment during a lifting/lowering operation. It's compact size means you can quickly and safely build a temporary crib to the desired height, with the flexibility of two configuration options depending on the required load capacities.

3-CRIB KIT 6

IP-72107

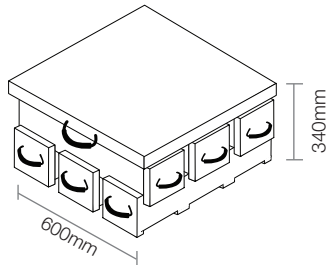

- 2 x 3 Crib Set-Up
- Weight 91.50kgs
- Load Capacity 30.00t
- 6 Cribbing Blocks
- 1 Top Pad (600x600x40mm)

3-CRIB KIT 9

IP-72108

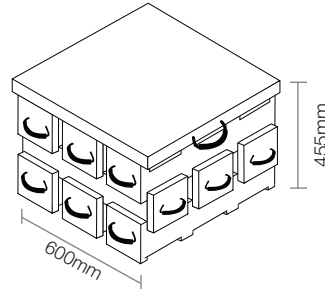

- 3 x 3 Crib Set-Up
- Weight 130.50kgs
- Load Capacity 40.00t
- 9 Cribbing Blocks
- 1 Top Pad (600x600x40mm)

3-CRIB KIT 12

IP-72109

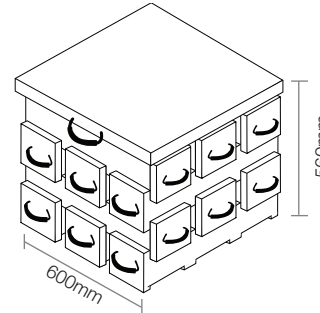

- 4 x 3 Crib Set-Up
- Weight 169.50kgs
- Load Capacity 50.00t
- 12 Cribbing Blocks
- 1 Top Pad (600x600x40mm)

3-CRIB KIT 15

IP-72110

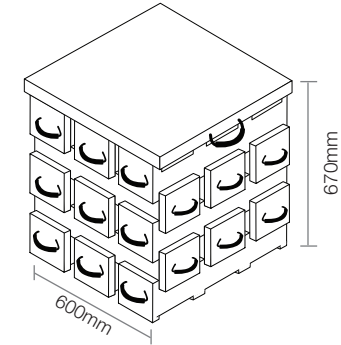

- 5 x 3 Crib Set-Up
- Weight 208.50kgs
- Load Capacity 60.00t
- 15 Cribbing Blocks
- 1 Top Pad (600x600x40mm)

3-CRIB KIT 18

IP-72111

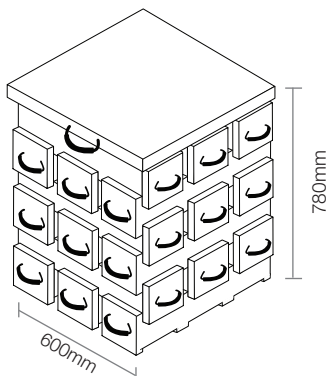

- 6 x 3 Crib Set-Up
- Weight 247.50kgs
- Load Capacity 70.00t
- 18 Cribbing Blocks
- 1 Top Pad (600x600x40mm)

3-CRIB KIT 21

IP-72112

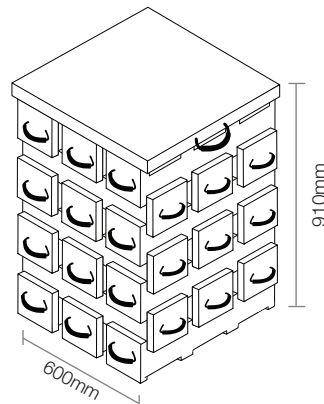

- 7 x 3 Crib Set-Up
- Weight 286.50kgs
- Load Capacity 80.00t
- 21 Cribbing Blocks
- 1 Top Pad (600x600x50mm)

3-CRIB KIT 24

IP-72113

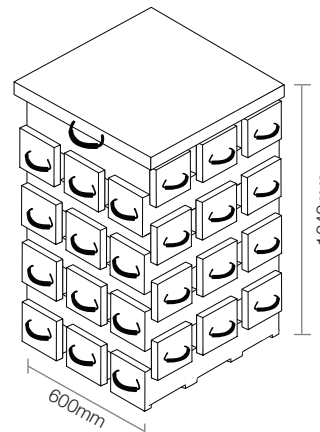

- 8 x 3 Crib Set-Up
- Weight 325.50kgs
- Load Capacity 100.00t
- 24 Cribbing Blocks
- 1 Top Pad (600x600x60mm)

3-CRIB KIT 27

IP-72114

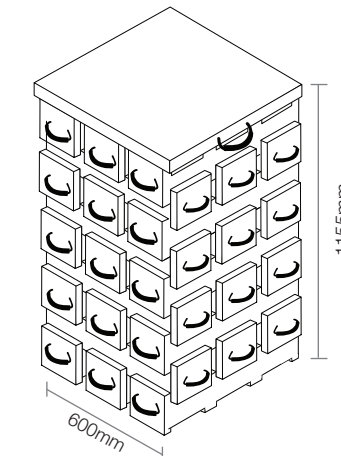

- 9 x 3 Crib Set-Up
- Weight 364.50kgs
- Load Capacity 115.00t
- 27 Cribbing Blocks
- 1 Top Pad (600x600x60mm)